

FL-710

OUTDOOR LIGHTING LUMINAIRE

Project _____
Location _____
Quote/ Ref # _____

The **FL-710** is an outdoor LED accent light with multiple beam and shroud options. It can rotate 360° and can be tilted 180° allowing for a more precise lighting scheme. Various accessories are available for different mounting options. Made of die-cast aluminum, it is extremely durable to ensure a longer lifetime. Its optimized heat dissipation allows the luminaire to be operated in extended lengths of time. Suitable for outdoor lighting such as building facades, gardens, lawns, tree accent lighting, and common outdoor areas.



SPECIFICATIONS

INPUT VOLTAGE	120V AC
WATTAGE	4W/ 8W
DIMMING	TRIAC Dimming
LUMEN OUTPUT	70Lm/ W
HOUSING	Die-cast Aluminum
FRONT COVER	Tempered Glass
FINISH TYPE	Powder Coating
DRIVER TYPE	Constant Current (Built-In)
AMBIENT TEMPERATURE	-4°F (-20°C) ~ 113°F (45°C)
IP RATING	IP65
CERTIFICATIONS	ETL

FEATURES

- 120V AC (No Transformer Needed)
- TRIAC Dimming
- Available in 4W and 8W
- Multiple optic Options
- 360° Rotate | 180° Tilt
- Die-cast Aluminum Housing
- IP65 Outdoor/ Wet Rated



MODEL	WATTS	COLOR TEMP	OPTICS	CRI	SHROUD	DIMMING	FINISH	ACCESSORIES	
FL-710	4 4W	27K 2700K	15 15°	80 Ra80	NS No Shroud	TRI TRIAC Dimming	BK Black	KC 4.5" Round Cover	HC Honeycomb Louver
		8 8W	30K 3000K	25 25°	90 Ra90	AS Angled Glare Shield	ND No Dimming	WH White	JB Junction Box
	35K 3500K		40 40°	OS Straight Glare Shield		D10* 0-10V Dimming	GR Gray	SHV High Voltage Ground Stake	PC Pole Clamp
	40K 4000K		AH H55° x V20°			BZ Bronze	PJB Tree Strap with Junction Box		
	50K 5000K	HV H20° x V55°			SI Silver	MBS Large Enclosure Box			

* Requires MBS
Large Enclosure
Box

FL-710

OUTDOOR LIGHTING LUMINAIRE

DIMENSIONS

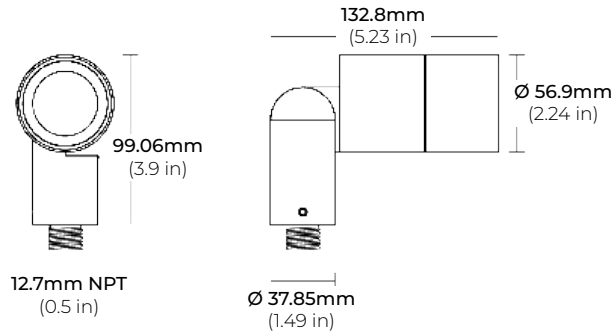

SHROUDS

AS
ANGLED GLARE SHIELD

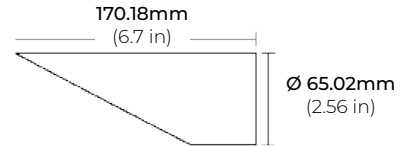

OS
STRAIGHT GLARE SHIELD

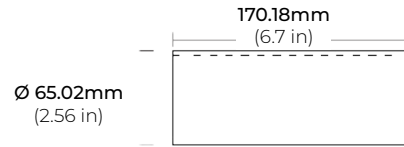

ACCESSORIES

FL700-KC
4.5" ROUND COVER

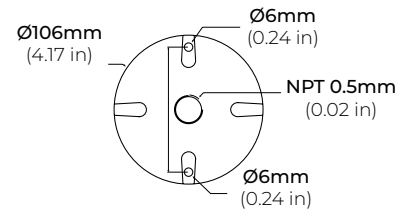

FL700-JB
JUNCTION BOX

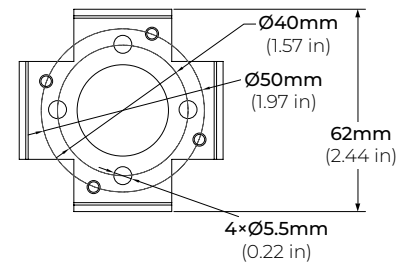
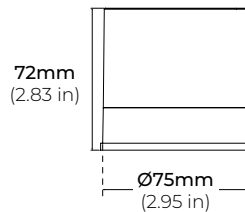
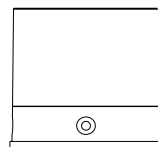

FL-710

OUTDOOR LIGHTING LUMINAIRE

ACCESSORIES

FL700-MBS
LARGE ENCLOSURE BOX

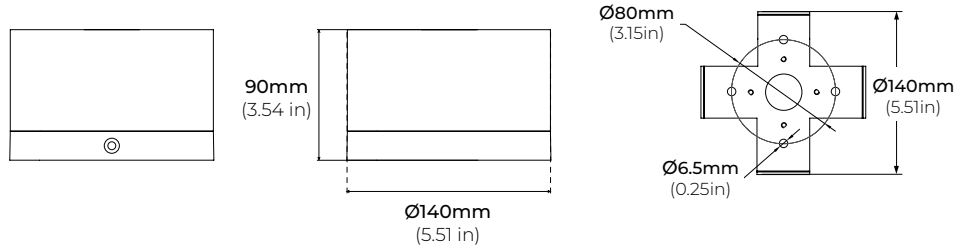

FL700-SHV
HIGH VOLTAGE GROUND STAKE

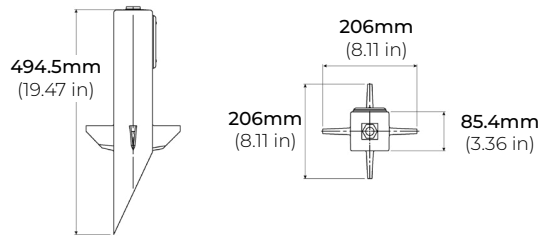

FL700-PJB
TREE STRAP WITH JUNCTION BOX

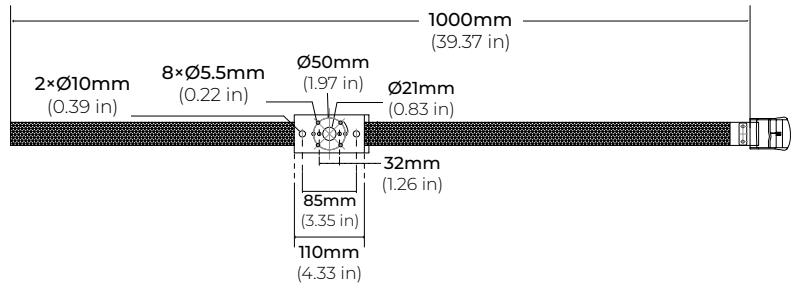

FL700-HC
HONEYCOMB LOUVER

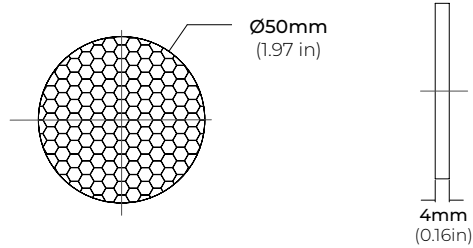

FL700-PC
POLE CLAMP

