

FL-730

120V OUTDOOR LIGHTING LUMINAIRE

Project _____
Location _____
Quote/ Ref # _____

The **FL-730** is an outdoor LED accent light with multiple beam and shroud options. It can rotate 360° and can be tilted 180° allowing for a more precise lighting scheme. Various accessories are available for different mounting options. Made of die-cast aluminum, it is extremely durable to ensure a longer lifetime. Its optimized heat dissipation allows the luminaire to be operated in extended lengths of time. Suitable for outdoor lighting such as building facades, gardens, lawns, tree accent lighting, and common outdoor areas.



SPECIFICATIONS

INPUT VOLTAGE	120V AC
WATTAGE	20W/ 30W/ 40W
HOUSING	Die-cast Aluminum
GASKET	Silicone Rubber
LENS	Tempered Glass
FINISH TYPE	Powder Coating
DRIVER TYPE	Constant Current (Built-In)
DIMMING	0-10V
AMBIENT TEMPERATURE	-4°F (-20°C) ~ 113°F (45°C)
IP RATING	IP65
CERTIFICATIONS	ETL Listed

FEATURES

- 120V AC (No Transformer Needed)
- 0-10V Dimming
- Available in 20W, 30W, and 40W
- Multiple Beam Patterns
- 360° Rotate | 180° Tilt
- Die-cast Aluminum Housing
- IP65 Outdoor/ Wet Rated

LUMENS

WATTS	30K (Lumens)
20W	2161
30W	2936
40W	3958



MODEL	WATTS	COLOR TEMP	OPTICS	SHROUD	FINISH	ACCESSORIES	DIMMING
FL-730	20 20W	27K 2700K	15 15°	NS No Shroud	BLK Black	KC 4.5" Round Cover	EB ¹ Electronic/ TRIAC Dimming
	30 30W	30K 3000K	24 24°	AS Angled Glare Shield	WH White	JB Junction Box	D10 ² 0-10V Dimming
	40 40W	40K 4000K	36 36°	OS Straight Glare Shield	GR Gray	SHV High Voltage Ground Stake	ND Non-Dimming
		50K 5000K	50 50°	HV H50° x V20°	BZ Bronze	SHV High Voltage Ground Stake	
					SI Silver	PC Pole Clamp	
						PJB Tree Strap with Junction Box	
						MBS Large Enclosure Box	

1= Not available for 40W
2= Requires MBS Large Enclosure Box

FL-730

120V OUTDOOR LIGHTING LUMINAIRE

DIMENSIONS

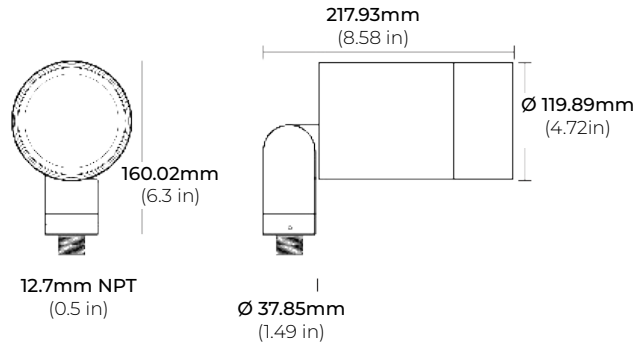

SHROUDS

AS
ANGLED GLARE SHIELD

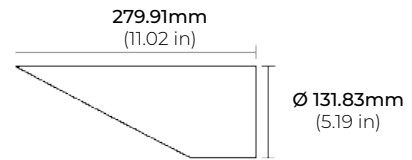

OS
STRAIGHT GLARE SHIELD

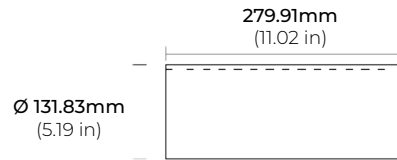

ACCESSORIES

FL700-KC
4.5" ROUND COVER

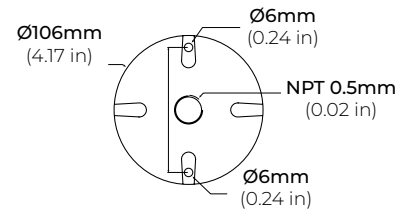

FL700-JB
JUNCTION BOX

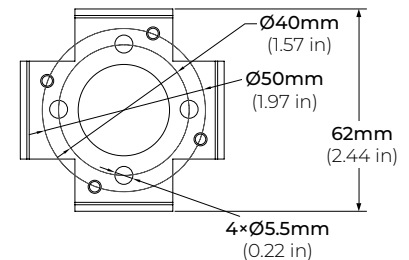
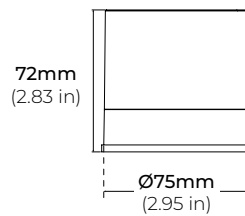
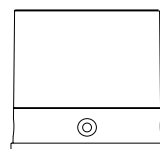

FL-730

120V OUTDOOR LIGHTING LUMINAIRE

ACCESSORIES

FL700-MBS
LARGE ENCLOSURE BOX

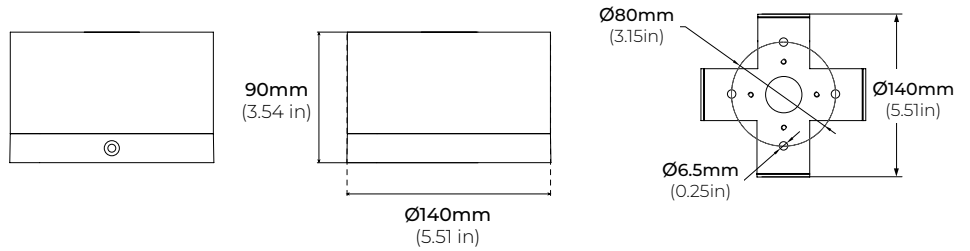

MP-400-SHV
HIGH VOLTAGE GROUND STAKE

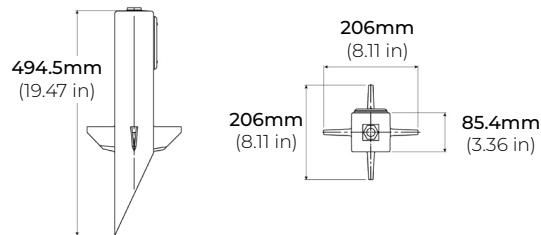

FL700-PJB
TREE STRAP WITH JUNCTION BOX

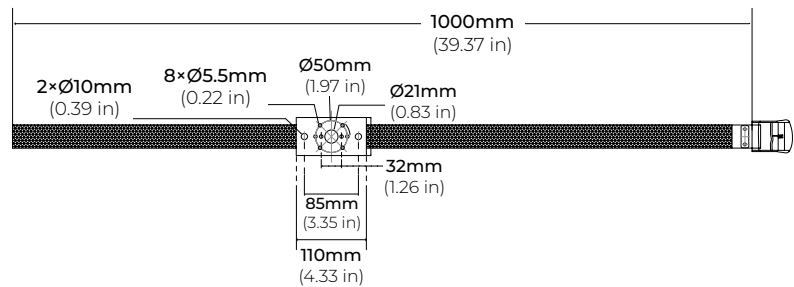

FL700-HC
HONEYCOMB LOUVER

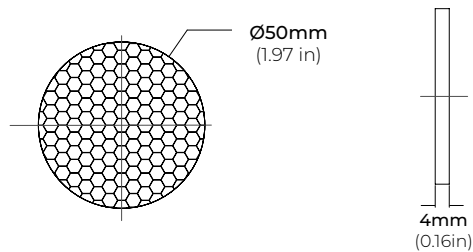

FL700-PC
POLE CLAMP

