

FL-710

OUTDOOR LIGHTING LUMINAIRE

Project _____
Location _____
Quote/ Ref # _____

The **FL-710** is an outdoor LED accent light with multiple beam and shroud options. It can rotate 360° and can be tilted 180° allowing for a more precise lighting scheme. Various accessories are available for different mounting options. Made of die-cast aluminum, it is extremely durable to ensure a longer lifetime. Its optimized heat dissipation allows the luminaire to be operated in extended lengths of time. Suitable for outdoor lighting such as building facades, gardens, lawns, tree accent lighting, and common outdoor areas.



SPECIFICATIONS

INPUT VOLTAGE	120V AC
WATTAGE	4W/ 6W/ 8W
DIMMING	TRIAC Dimming
LUMEN OUTPUT	70Lm/ W
HOUSING	Die-cast Aluminum
FRONT COVER	Tempered Glass
FINISH TYPE	Powder Coating
DRIVER TYPE	Constant Current (Built-In)
AMBIENT TEMPERATURE	-20 ~ 45°C (-4 ~ 113°F)
IP RATING	IP65
CERTIFICATIONS	ETL

FEATURES

- 120V AC (No Transformer Needed)
- TRIAC Dimming
- Available in 4W, 6W, and 8W
- Multiple optic Options
- 360° Rotate | 180° Tilt
- Die-cast Aluminum Housing
- IP65 Outdoor/ Wet Rated



MODEL	WATTS	COLOR TEMP	OPTICS	CRI	SHROUD	FINISH	ACCESSORIES	
FL-710	L1 4W	27K 2700K	15 15°	80 Ra80	NS No Shroud	BK Black	KA Mounting Bracket A	HC Honeycomb Louver
	L2 6W	30K 3000K	25 25°	90 Ra90	AS Angled Glare Shield	WH White	KB Mounting Bracket B	MR Marine Ambient Corosion Resistant
	L3 8W	40K 4000K	40 40°	AH H55° x V20°	OS Straight Glare Shield	GR Gray	KC 4.5" Round Cover	PC Pole Clamp
		50K 5000K	HV H20° x V55°			BZ Bronze	JB Junction Box	
						SI Silver	SHV High Voltage Ground Stake	
							PJB Tree Strap with Junction Box	

FL-710

OUTDOOR LIGHTING LUMINAIRE

DIMENSIONS

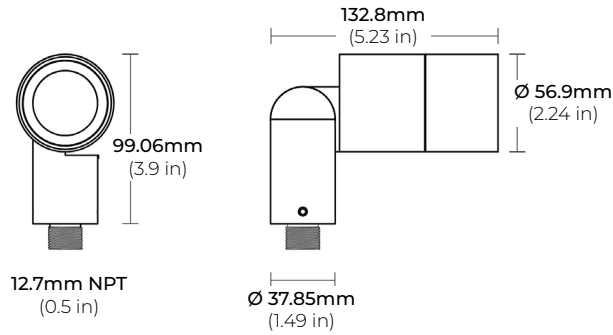

SHROUDS

AS
ANGLED GLARE SHIELD

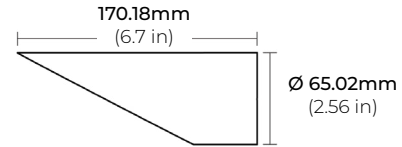

OS
STRAIGHT GLARE SHIELD

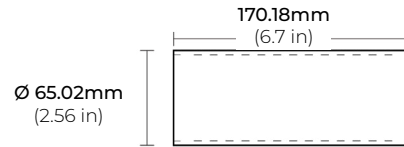

ACCESSORIES

KA
MOUNTING BRACKET A

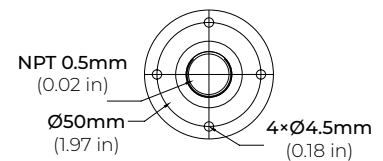
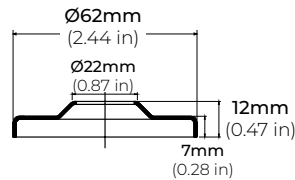

KB
MOUNTING BRACKET B

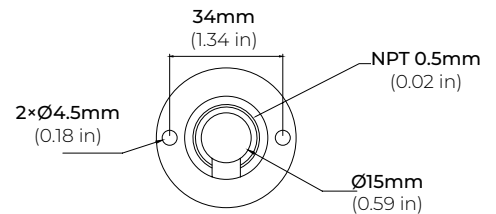
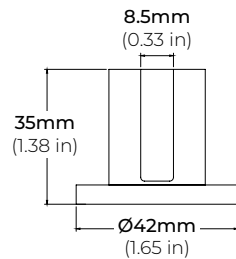

KC
4.5" ROUND COVER

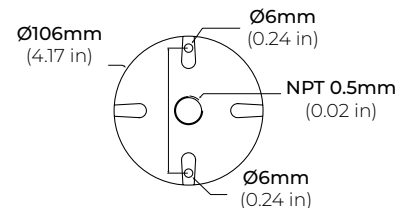

FL-710

OUTDOOR LIGHTING LUMINAIRE

ACCESSORIES

JB
JUNCTION BOX

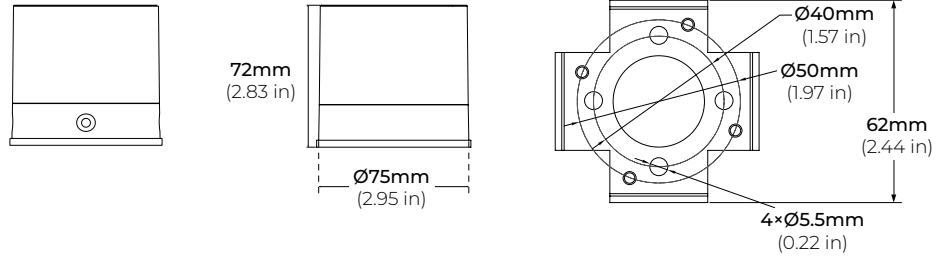

SHV
HIGH VOLTAGE GROUND STAKE

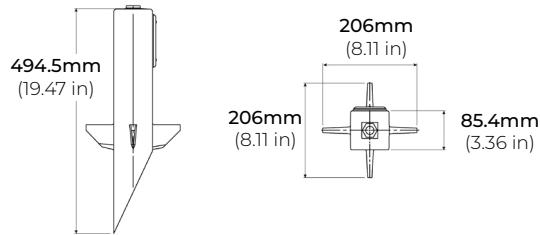

PJB
TREE STRAP WITH JUNCTION BOX

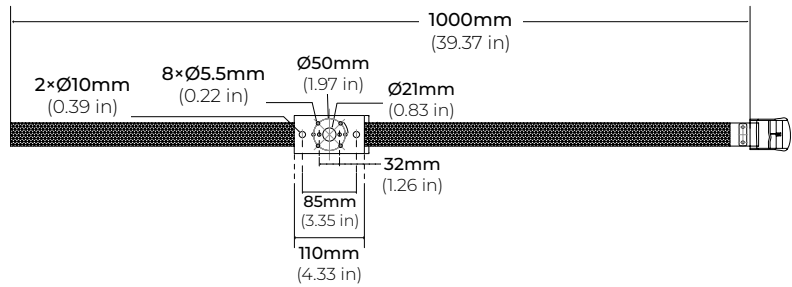

HC
HONEYCOMB LOUVER

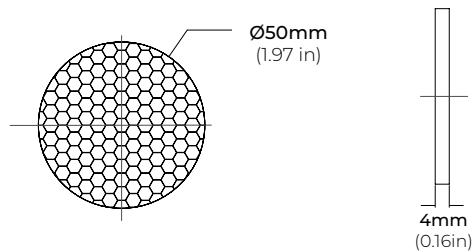

PC
POLE CLAMP

