

SPECIFICATION SHEET

JOB NAME: _____
 LOCATION: _____
 QUOTE/REF#: _____



ROC LIGHTING introduces its Architectural Grade outdoor lighting luminaires. Machined from military grade solid aluminum, and treated with a special chromation process, ROC fixtures are designed to withstand the harshest environments, and provide a long lasting durable light source. These premium outdoor lighting fixtures a great source of light in uplight or downlight applications such as landscape lighting, tree-mounted lighting or wall accent/security lighting. Rated for Wet Location.

FEATURES

- Architectural Grade Outdoor Luminaire
- Military Grade Solid Aluminum
- MR16 Adjustable
- Suitable for landscape, tree-mounted / accent lighting
- Outdoor / Wet Location

SPECIFICATIONS

MATERIAL	Precision Machined Aluminum
LAMPING	12V MR16 Bi-Pin Halogen (Lamp Not Included)
VOLTAGE	12 Volts
WATTAGE	50W Maximum
RATING	Dry, Damp or Wet Location
LENS	Up to 3 lens accessories can be specified.
MOUNTING	1/2" NPS Thread.
FINISHES	Black / Bronze / White / silver Anodized
TRANSFORMER	Required (not included)
WARRANTY	3-Year Limited

DIMENSIONS

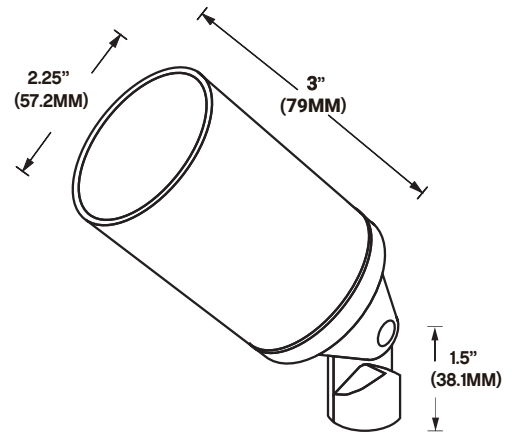

ORDERING GUIDE EX: FL401-BZ-STD-L1

FL401			
MODEL	FINISH	CAP STYLE	OPTIONAL LENS ACC
	WH - White BK - Black BZ - Bronze SI - Silver	STD - Standard Bezel SAG - Short Angle Bezel LAG - Long Angle Bezel	L1 - Soft Focus L2 - Spread L3 - Liner L4 - Frost L5 - Honeycomb

CAP STYLE OPTIONS

STD | Standard Bezel

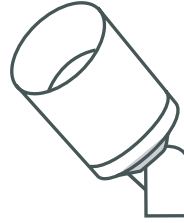

SAG | Short Angle Bezel

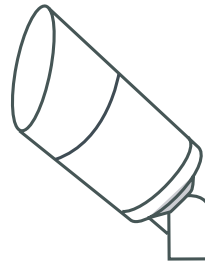

LAG | Long Angle Bezel

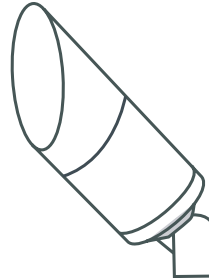

CAP STYLE OPTIONS

CP-301

FINISH OPTIONS

- | | |
|---------------------------|------------------------|
| ■ 3/0 Flat Aluminum Plate | ■ SA - Silver Anodized |
| ■ Single Mounting Hole | ■ BK - Black |
| ■ 4.75" Round Diameter | ■ BZ - Bronze |
| ■ 1/2" NPS Thread | ■ WH - White |

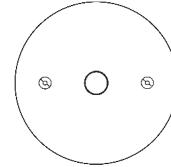

CP-302

FINISH OPTIONS

- | | |
|---------------------------|------------------------|
| ■ 3/0 Flat Aluminum Plate | ■ SA - Silver Anodized |
| ■ Double Mounting Hole | ■ BK - Black |
| ■ 4.75" Round Diameter | ■ BZ - Bronze |
| ■ 1/2" NPS Thread | ■ WH - White |

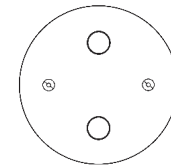

CP-401

FINISH OPTIONS

- | | |
|---------------------------|------------------------|
| ■ 4/0 Flat Aluminum Plate | ■ SA - Silver Anodized |
| ■ Single Mounting Hole | ■ BK - Black |
| ■ 4.75" Round Diameter | ■ BZ - Bronze |
| ■ 1/2" NPS Thread | ■ WH - White |

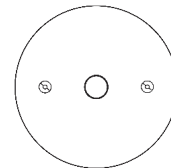

CP-402

FINISH OPTIONS

- | | |
|---------------------------|------------------------|
| ■ 4/0 Flat Aluminum Plate | ■ SA - Silver Anodized |
| ■ Double Mounting Hole | ■ BK - Black |
| ■ 4.75" Round Diameter | ■ BZ - Bronze |
| ■ 1/2" NPS Thread | ■ WH - White |

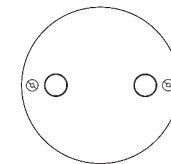

CP-403

FINISH OPTIONS

- | | |
|---------------------------|------------------------|
| ■ 4/0 Flat Aluminum Plate | ■ SA - Silver Anodized |
| ■ Triple Mounting Hole | ■ BK - Black |
| ■ 4.75" Round Diameter | ■ BZ - Bronze |
| ■ 1/2" NPS Thread | ■ WH - White |

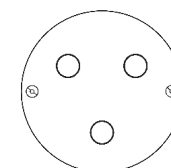

ACCESSORIES

MB-100 | Tree Surface Canopy

- 1/2" NPS Thread
- 1" Height
- 2 1/4" diameter

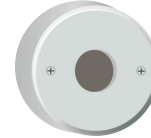

MB-200 | Mini Surface Wiring Box

- 1/2" NPS Thread
- 1 5/8" Height
- 2 1/4" diameter

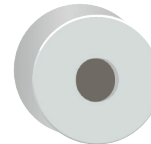

MB-400 | Round Surface Canopy

- Mounting onto 4/0 or 3/0 boxes
- 1 1/4" Height
- 4 3/4" diameter



MB-500 | Round Surface Canopy

- Surface Mount 1/2" NPS Thread
- 1 1/4" Height
- 4 3/4" diameter



MP-100 | Composite Mounting Spike

- 1/2" Female Thread
- 8 3/4" Height
- 2" diameter

