

SPECIFICATION SHEET

JOB NAME: _____
 LOCATION: _____
 QUOTE/REF#: _____



The **IG-300** is a 3W dimmable in-grade LED fixture designed for outdoor recessed applications commonly used to illuminate pathways and walkways. Capable of 160 Lumens of light output, this easy to install fixture provides optimal lighting in a stylish design.

FEATURES

- 12V AC/DC
- Suitable for interior exterior applications.
- Stainless steel finish.
- Die-cast aluminum face plate.
- 3000K color temperature.
- Suitable for wet locations.
- Dimmable
- Rated to last 50,000 hrs.

SPECIFICATIONS

VOLTAGE	12V AC/DC
POWER CONSUMPTION	2W
LUMEN OUTPUT	160 Lumens
OPERATING FREQUENCY	50 / 60Hz
CCT	4000K
CRI	85+
DIMMING	YES
IP RATING	IP65 wet location
OPERATING TEMPERATURE	-4 ~ 122°F (-20 ~ 50°C)
AMBIENT TEMPERATURE	-4 ~ 176°F (-20 ~ 80°C)
LUMEN MAINTENANCE	50,000 hrs.
CONNECTION	20" 18AWG Lead Wire
WARRANTY	3-Year Limited
HOUSING DIMENSIONS	2.45" Ø x 3.42" H
FACE PLATE DIMENSIONS	3.47" Ø x 0.80" H

DIMENSIONS

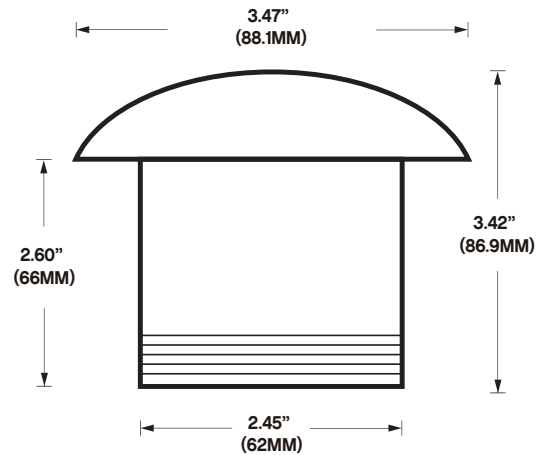

ORDERING GUIDE EX: ST800-30K-BZ-24V

MODEL	COLOR TEMP	FINISH	VOLTAGE
IG301 IG302 IG303 IG304	40K - 4000K	BK - Black SI - Silver	12V- 12V AC/DC

FACE PLATE OPTIONS

<p>IG301</p>	
<p>IG302</p>	
<p>IG303</p>	
<p>IG304</p>	