

SPECIFICATION SHEET

JOB NAME: _____
 LOCATION: _____
 QUOTE/REF#: _____

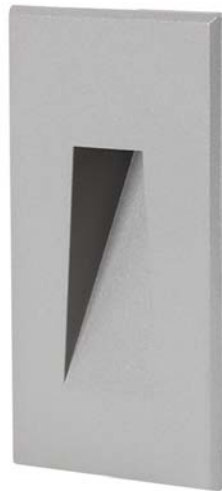

ST-200 is a 3W, 24V outdoor luminaire intended for use as stair and wall lights. Illuminate paths and walkways or mount these onto walls to shine down on surface or floor. IP67 outdoor rated to withstand all weather conditions. Ideal for residential and commercial applications.

FEATURES

- Recessed applications
- Up to 75 lumens
- Superior Color Rendering Index (90+ CRI)
- Die-cast powder coated aluminum
- Available in White, Black and Silver
- IP67 outdoor rated
- Great dimming performance
- Dimmable with most TRIAC, MLV and ELV dimmers



SPECIFICATIONS

INPUT VOLTAGE	24V DC
POWER CONSUMPTION	3W
LUMEN OUTPUT	Warm White (30K) = 72 lumens Cool White (40K) = 75 lumens
BEAM ANGLE	120°
CCT	3000K, 4000K
CRI	90+
DIMMING	TRIAC, MLV, and ELV
OPERATING TEMPERATURE	-20°C ~ 40°C
LED	OSRAM LED
MOUNTING	Recessed
LUMEN MAINTENANCE	50,000 hrs.
IP RATING	IP67 outdoor
FINISH OPTIONS	White, Black and Silver
CERTIFICATIONS	RoHS, ETL

FINISH OPTIONS



DIMENSIONS

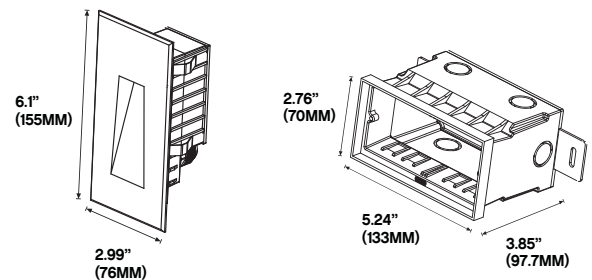

ORDERING GUIDE EX: ST200-30K-BK-24

ST-200			
MODEL	COLOR TEMP	FINISH	VOLTAGE
	30K - 3000K 40K - 4000K	WH - WHITE BK - BLACK SI - SILVER	24 - 24V DC

ST-200 Recessed LED Luminaire

COMPATIBLE DIMMABLE TRANSFORMERS

MAGNETIC LOW VOLTAGE (MLV)

		CLASS 2	L X W X H
PSDM SERIES	PSDM-20W-12V	YES	5.6" X 2" X 2.14"
	PSDM-40W-12V	YES	5.6" X 2" X 2.14"
	PSDM-60W-12V	YES	6.5" X 2.3" X 2.5"
	PSDM-100W-12V	NO	9.8" X 3" X 3"
	PSDM-150W-12V	NO	9.8" X 3" X 3"
	PSDM-180W-12V-CL2	YES	9.8" X 3" X 3"
	PSDM-200W-12V	NO	9.8" X 3" X 3"
	PSDM-300W-12V	NO	9.8" X 4.2" X 3.5"
PSDM-300W-12V-CL2	YES	7.0" X 7.0" X 3.2"	
PSDM SERIES	PSDM-20W-24V	YES	5.6" X 2" X 2.14"
	PSDM-40W-24V	YES	5.6" X 2" X 2.14"
	PSDM-60W-24V	YES	6.5" X 2.2" X 2.5"
	PSDM-100W-24V-CL2	YES	6.5" X 2.2" X 2.5"
	PSDM-150W-24V	NO	9.8" X 3" X 3"
	PSDM-192W-24V-CL2	YES	7.0" X 7.0" X 3.2"
	PSDM-200W-24V	NO	9.8" X 3" X 3"
	PSDM-300W-24V	NO	9.8" X 4.2" X 3.5"
PSDM-288W-24V-CL2	YES	7.0" X 7.0" X 3.2"	

* 277 VERSIONS AVAILABLE, PLEASE CONSULT FACTORY

HIGH PERFORMANCE MLV

		CLASS 2	L X W X H
PSDH SERIES	PSDH-48W-24V	YES	11.25" X 3.37" X 3.25"
	PSDH-96W-24V	YES	11.25" X 3.37" X 3.25"
	PSDH-288W-24V	YES	14.25" X 8.43" X 4.43"

* 277 VERSIONS AVAILABLE, PLEASE CONSULT FACTORY

TRIAC DIMMING ELECTRONIC

		CLASS 2	L X W X H
PSDT SERIES	PSDT-20W-12V	YES	6.1" X 2.12" X 0.79"
	PSDT-20W-24V	YES	6.1" X 2.12" X 0.79"
	PSDT-40W-12V	YES	7.0" X 2.4" X 0.95"
	PSDT-40W-24V	YES	7.0" X 2.4" X 0.95"
	PSDT-60W-12V	YES	7.1" X 2.36" X 1.38"
	PSDT-60W-24V	YES	7.1" X 2.36" X 1.38"
	PSDT-96W-24V-JB	YES	9.06" X 2.76" X 1.82"
	PSDT-120W-12V-JB	NO	8.92" X 3.0" X 1.85"
	PSDT-150W-24V-JB	NO	8.92" X 3.0" X 1.85"
PSDT-200W-24V-JB	NO	8.92" X 3.0" X 1.85"	

ST-200 Recessed LED Luminaire

COMPATIBLE DIMMABLE TRANSFORMERS

0-10 DIMMING WITH JUNCTION BOX

		CLASS 2	L X W X H
PSDE SERIES	<u>PSDE-100W-24V-010-JB</u>	YES	12.32" X 1.77" X 1.67"

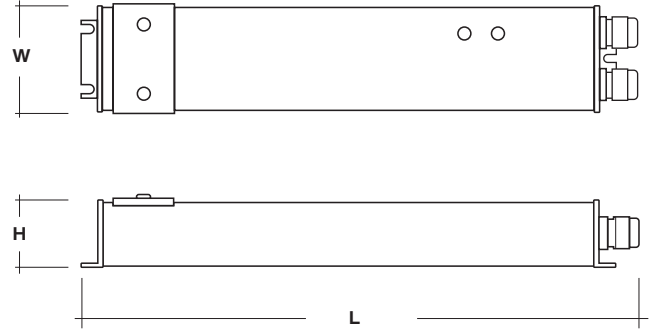

LUTRON 1% DIMMING

		CLASS 2	L X W X H
2-WIRE	<u>LTEA4U1UKL-CV240</u>	YES	4.0" X 1.5" X 4.0"
3-WIRE	<u>L3DA4U1UKL-CV240</u>	YES	4.0" X 1.5" X 4.0"

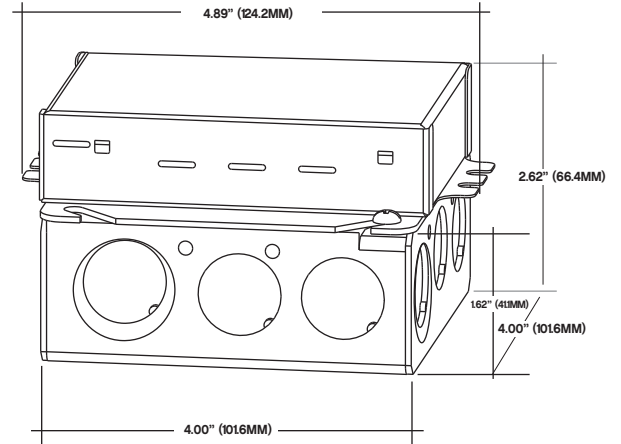

LUTRON .1% DIMMING

		CLASS 2	L X W X H
PSDE SERIES	<u>PSDE-96W-24V-ECO</u>	YES	10.5" X 3.0" X 2.0"

